

BIGBAT

6V. 12 Ah.

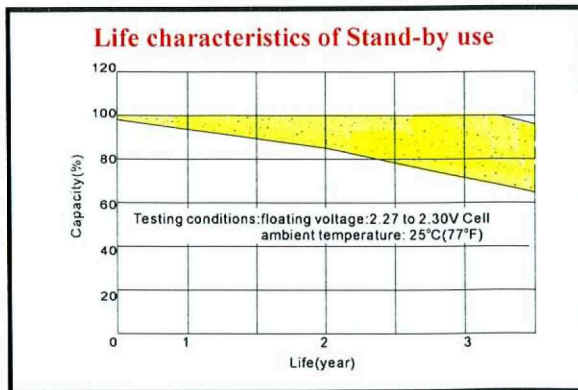
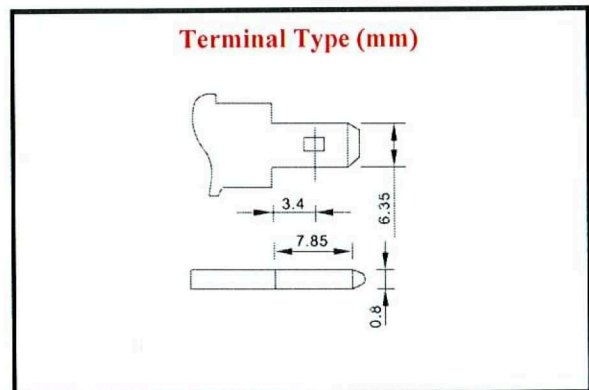
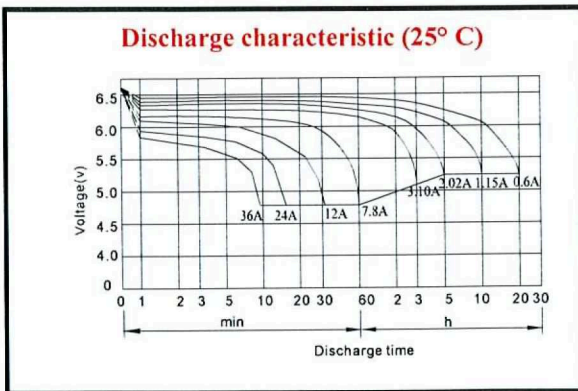
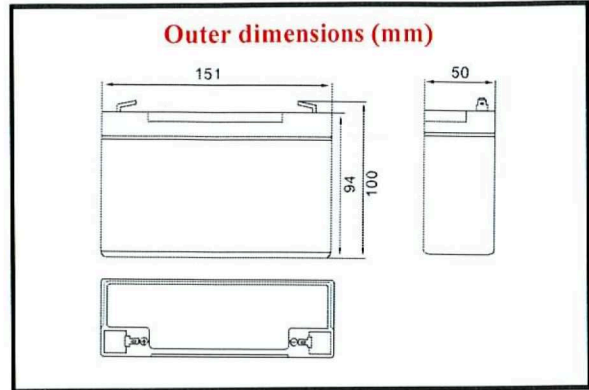

Characteristics

Capacity 25° C (77° F)	20 hour rate (0.60 A) 10 hour rate (1.15 A) 5 hour rate (2.02 A) 1 hour rate (7.80 A)	12.00 AH 11.50 AH 10.10 AH 7.80 AH
	1.5 hour discharge to 5.25V	4.80 A
Internal Resistance	Full charged battery at 25° C (77° F)	9 mΩ
Capacity effected by temperature (20 hour rate)	40° C (104° F) 25° C (77° F) 0° C (32° F) -15° C (5° F)	102 % 100 % 85 % 65 %
Self-discharge at 25° C (77° F)	Capacity after 3 month storage Capacity after 6 month storage Capacity after 12 month storage	91 % 82 % 64 %
Charge (constant voltage)	Cycle	Initial charging current less than 4.0A Voltage 7.30 – 7.50V.
	Float	Voltage 6.90 – 7.00V.

