

BIGBAT

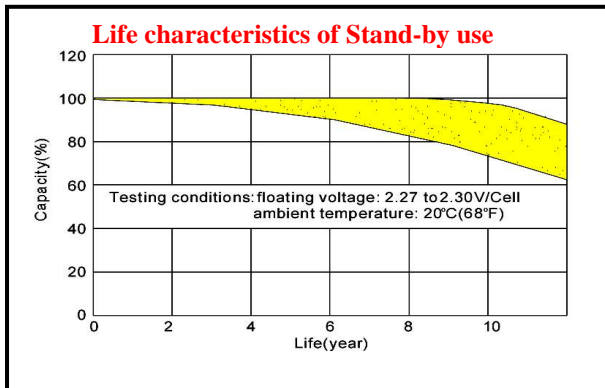

LONG LIFE 2V.3000Ah.

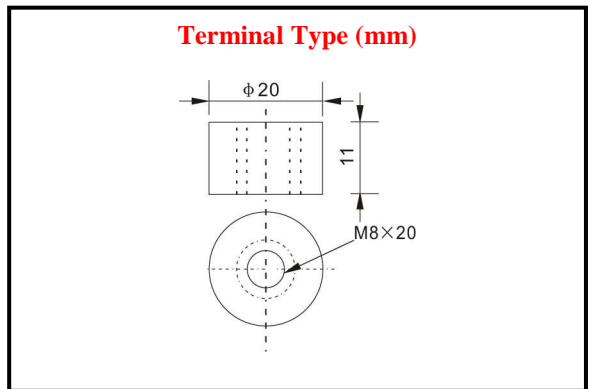
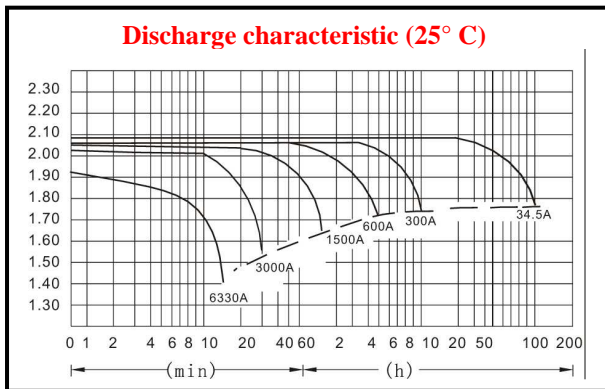
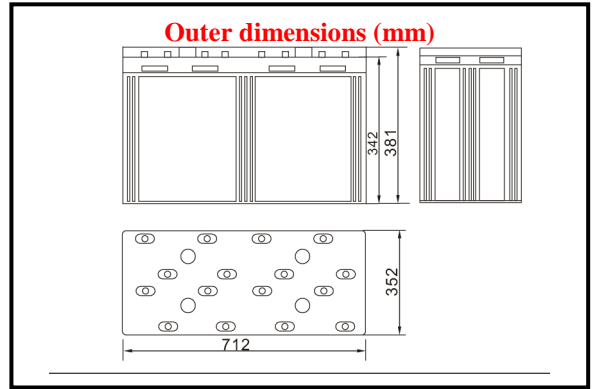

Characteristics

Capacity 25° C (77° F)	10 hour rate (300 A) 5 hour rate (480 A) 1 hour rate (1650 A)	3000 AH 2400 AH 1650 AH
	1.5 hour discharge to 1.75V	1200 A
Internal Resistance	Full charged battery at 25° C (77° F)	1.6 m Ω
Capacity effected by temperature (20 hour rate)	40° C (104° F)	102 %
	25° C (77° F)	100 %
	0° C (32° F)	85 %
	-15° C (5° F)	65 %
Self-discharge at 25° C (77° F)	Capacity after 3 month storage	91 %
	Capacity after 6 month storage	82 %
	Capacity after 12 month storage	64 %
Charge (constant voltage)	Cycle	Initial charging current less than 750 A Voltage 2.35 – 2.40V.
	Float	Voltage 2.25 – 2.30V.

