

BIGBAT

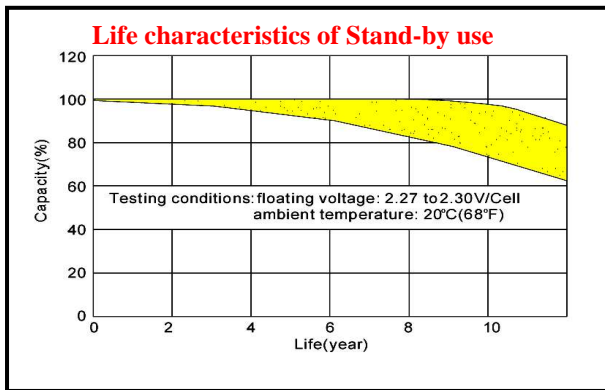

LONG LIFE

2V. 400Ah.

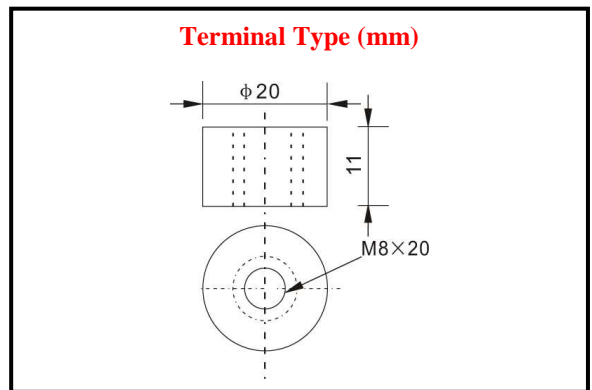
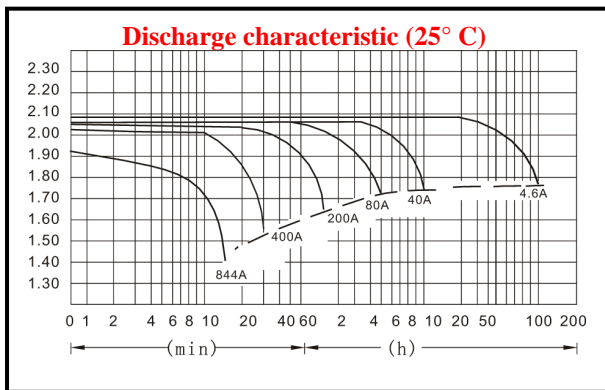
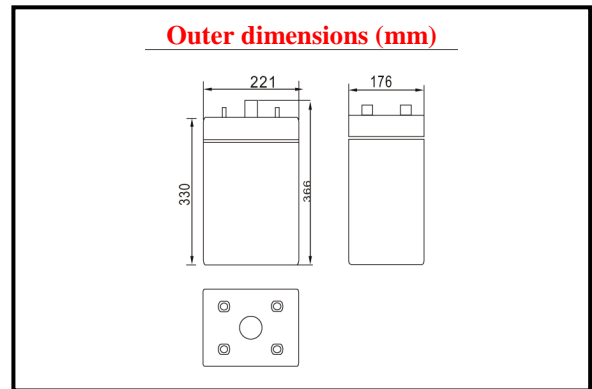

Characteristics

Capacity 25° C (77° F)	10 hour rate (40 A) 5 hour rate (64 A) 1 hour rate (220 A)	400 AH 320 AH 220 AH
	1.5 hour discharge to 1.75V	160 A
Internal Resistance	Full charged battery at 25° C (77° F)	1.5 m Ω
Capacity effected by temperature (20 hour rate)	40° C (104° F)	102 %
	25° C (77° F)	100 %
	0° C (32° F)	85 %
	-15° C (5° F)	65 %
Self-discharge at 25° C (77° F)	Capacity after 3 month storage	91 %
	Capacity after 6 month storage	82 %
	Capacity after 12 month storage	64 %
Charge (constant voltage)	Cycle	Initial charging current less than 100 A Voltage 2.35 – 2.40V.
	Float	Voltage 2.25 – 2.30V.

